

sales & service

rigging tackle | lifting equipment | ppe | truss | control equipment

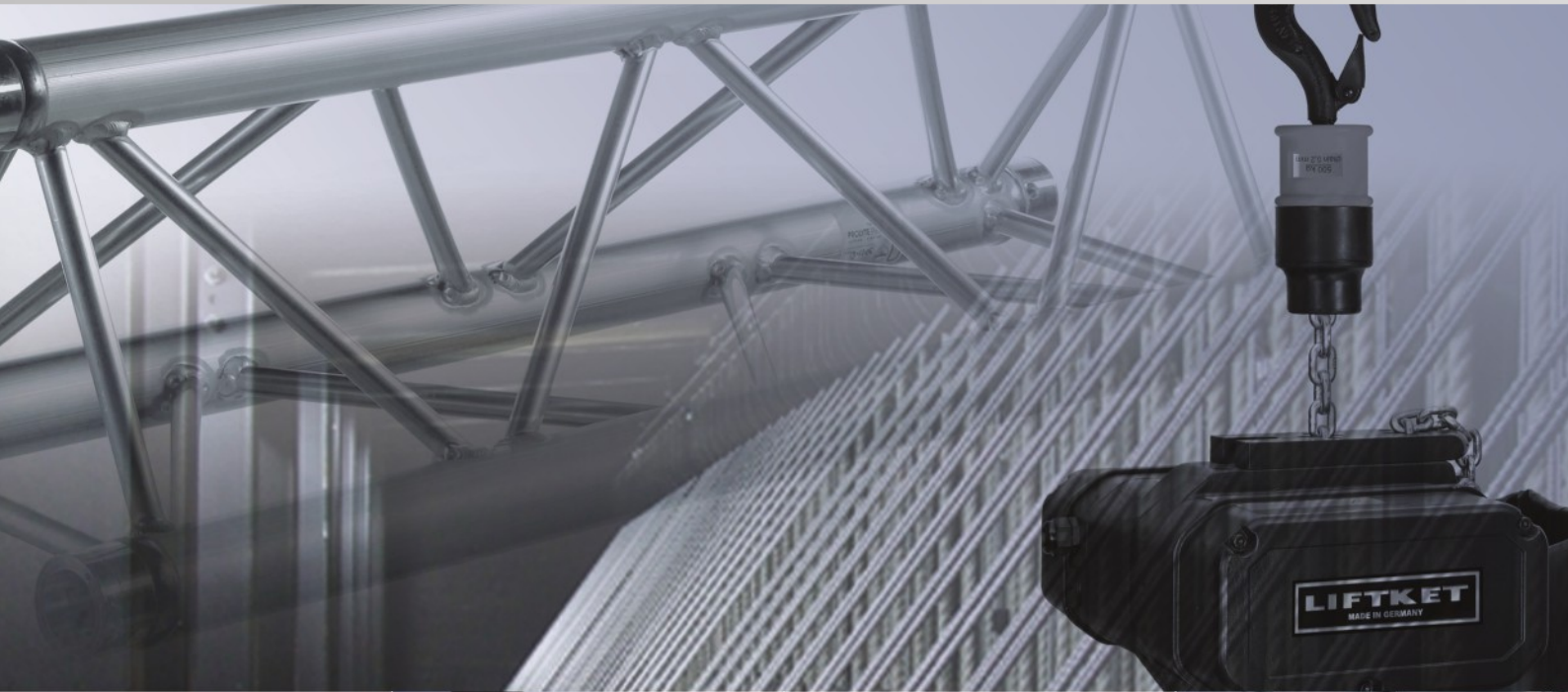

sales & service



LIFTKET



 **PROLYTE
GROUP**



welcome to Unusual's sales & service

Although known principally as a solutions and rental company, Unusual Rigging is also the sales and service partner for several manufacturers, as well as the designer and manufacturer of a range of our own products. With a 35 ton horizontal test bed and a 350 ton wire rope press on site, we can manufacture custom products as well as standard rigging items.

This brochure is designed to give you an overview of the many products available from Unusual, including electric chain hoists, chain and steel wire rope slings, distro/motor control, fibre and wire rope, hoists and winches, manual lifting equipment, safety and access equipment, truss, webbing products and many other rigging related items.

You can order through our website, by emailing sales@unusual.co.uk or simply by calling us on 01604 830083.





As well as being high quality, all Prolyte products are durable, easy to assemble and very user friendly, ensuring our clients get excellent value and maximum flexibility at affordable prices.

The X & H 30 series and H40 series are designed as lightweight, light to medium duty truss systems for the installation, rental and exhibition market. Strong, compact and very versatile, they have a low self-weight and the continuous webbing of the diagonals makes assembly fool proof.

The S52 truss comprises main tubes of 50 x 4mm and diagonals of 25 x 3mm (S52F) or 30 x 3mm (S52V and SV), and uses the CCS7 coupling system.



H30V



for medium-duty to heavy-duty trussing



high-tech staging

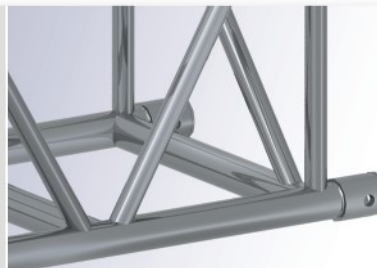



H30V

Top View

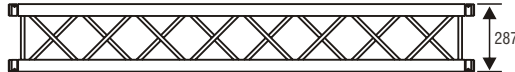

Side View

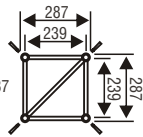
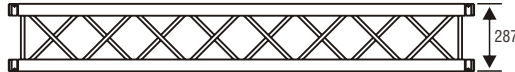

H40V

Top View

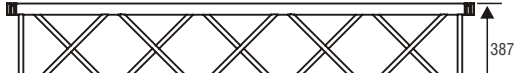

Side View

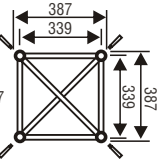

S52SV - S52V

Top View S52SV

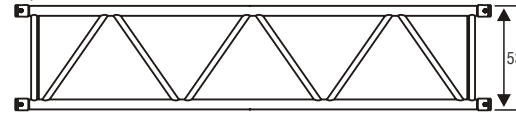

Top View S52V

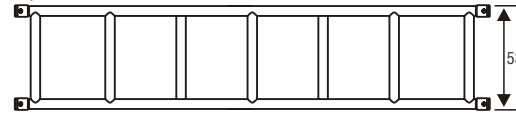

Side View S52SV - S52V

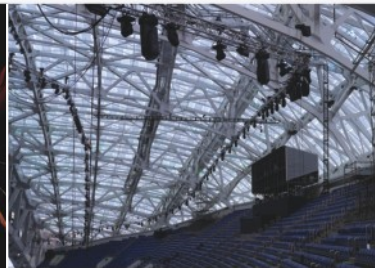
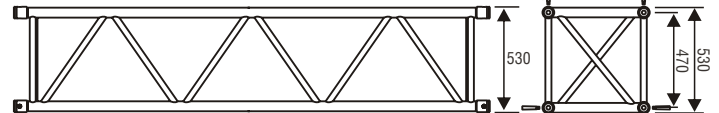

sales & service



 STAGE
DEX

STAGE DEX

The StageDex range, which comprises ProExpoFloor, LiteDeck and StageDex, is designed specifically for temporary flooring systems or demountable platforms and stages. Efficient and lightweight, with a very high loading capacity, it is the result of long-term practical experience combined with advanced design and manufacturing techniques.

Smart and high-tech, yet flexible, safe and practical, this wide range of standardised products affords maximum configuration flexibility and the best value for money. StageDex products are very user-friendly: they can be assembled by anyone with minimal prior training, few tools are needed and storage is easy and efficient.

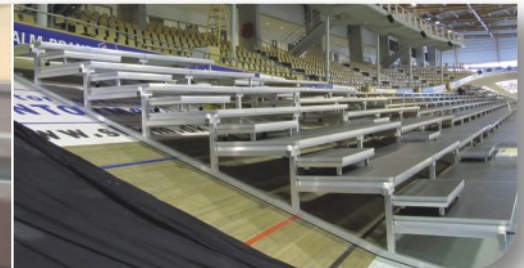
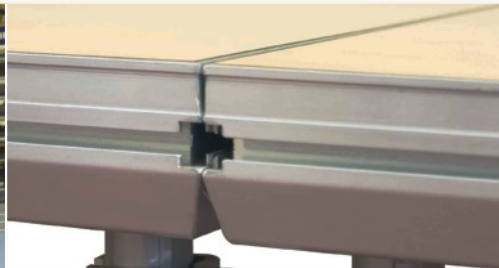

LIFTKET

The Liftket range of entertainment chain hoists, for which Unusual is the sole UK distributor, is by far the most popular with our clients. The units benefit from many various options in speed and add on extras such as double brakes and multiple limits. Liftket can supply 125-25000kg SWL.

While the following are the most popular Liftket hoists, more are available:

BGV-D8

- 250-5000kg capacities
- Aluminium housing
- Compact and robust
- Climbing or standard suspension
- Precise chain guide
- Five pocket chain wheel
- DC brake
- Friction clutch for overload protection

BGV-D8+

- 125 - 2500kg capacities
- 2 DC brakes
- Aluminium housing
- Compact and robust
- Climbing or standard suspension
- Precise chain guide
- Five pocket chain wheel
- Friction clutch for overload protection

BGV-C1

- 125 - 2500kg capacities
- DIN 5684 Load Chain
- Contactor Control 24VAC/DC
- Low Noise running
- 5-Pocket Chain Wheel
- 2 DC Brakes
- Gear Limit Switch
- 10 x dynamic Safety Factor
- Friction Clutch is not in the Load Path



Stageket

A new chain hoist from Liftket specifically designed for the entertainment industry. Stageket combines the technology used to manufacture the Liftket and STAR Liftket chain hoists:

Available in D8, D8+ & C1

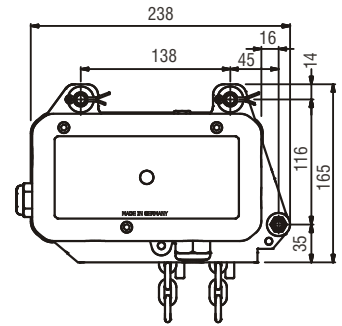
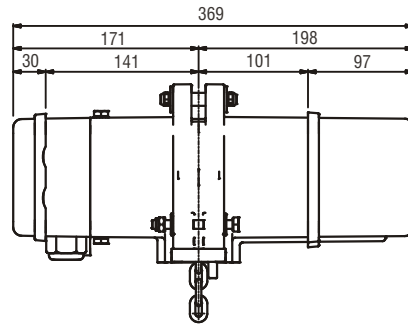

*Dimensions shown are that of a standard D8 model



chain bags

These chain bags are manufactured with tested material and certified hardware for high performance. Available in five sizes, they fit the all the main chain hoist brands used in the entertainment industry, including Liftket.

Two high resistance polyester straps take the weight of the chain and distribute it over the upper metal frame. The straps criss-cross underneath the bag to increase the loading capacity and prevent the bottom falling through, even in the case of very long chains.

The strength and flexibility of the fabric, the quality of the sewing and the certified materials ensure these chain bags are unrivalled.





Established in 1970, Doughty Engineering is one of the world's leading manufacturers of grip, rigging and suspension equipment, supplying products to broadcast, film, TV and entertainment industries. All Doughty branded products are made in the company's 2,300m² factory in Ringwood, Hampshire, ensuring full control over the quality and production, and no delays in getting a special product to a theatre anywhere in the UK. Over the years the company's ability to fabricate specials for customers, and carry stock of the more important ones, has led to a product range of over 1,300 items.

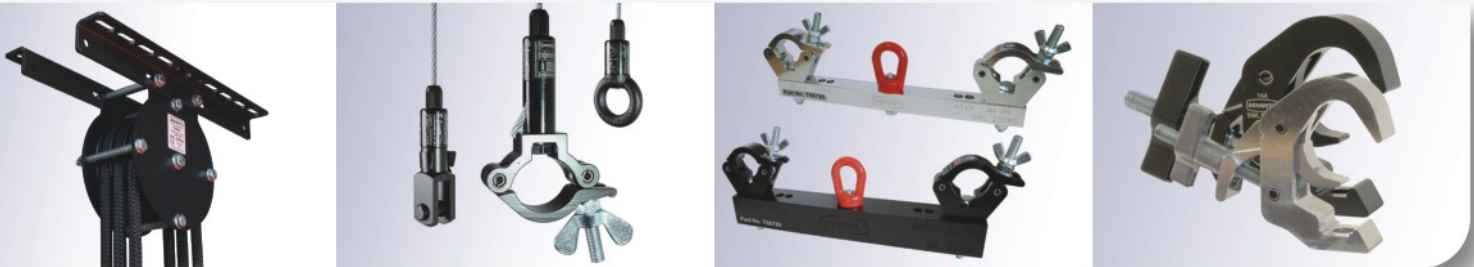

personal protection equipment

Personal protective equipment (PPE) is designed to protect people from serious workplace injuries or illnesses resulting from contact with hazardous elements. PPE includes a variety of devices and garments such as goggles, overalls, gloves, vests, earplugs and respirators.

Unusual Rigging is a distributor for the Lyon group of brands and so can supply a huge range of products for work at height and rescue, including technical and non-technical textile and wire based products, from ladders and 'black' slings through to rope and kit bags.

As well as producing high quality individual items Lyon also assembles equipment into bespoke kits that will enable you, with specific training, to undertake work or rescues from height or confined spaces, including:

- Pick-off type rescue kits for construction, theatre and Emergency Service users
- Personal evacuation kits for forklifts in high bay warehouses, mobile elevating working platforms and from high level 'mast climbing' suspended platforms

Unusual Rigging can supply equipment from any of the brands shown below:



personal protection equipment

When choosing equipment, ensure it:

- Is suitable for the particular circumstance of the task
- Can be used for the particular task within its design limits
- Meets the relevant standard
- Has a compatible component, so that the safe function of one component is not adversely affected by, and does not interfere with, another.

This is a recommended kit list for work positioning & basic fall arrest techniques:

- 1 x Petzl AVAO full body harness
- 1 x Petzl Double absorbica lanyard
- 1 x Petzl Grillon & hook 3m
- 1 x Petzl Vertex best helmet
- 10 x Lyon Karabiners
- 1 x Harken pulley
- 1 x Beal Hauling line
- 1 x Petzl rope bag
- 1 x Petzl Head torch
- 1 x Petzl Tool bag
- 2 x Lyon 1m climbing tapes
- 2 x Lyon 0.5m climbing tapes
- 1 x Beal Pair of Gloves

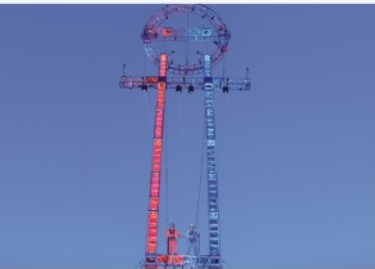

rigging tackle

Unusual maintains stocks of a broad range of component parts for the manufacture of rigging assemblies. Steel wire rope ranging from 1.5mm to 20mm diameter, as well as ferrules and thimbles for assembling wire rope slings are always in stock to ensure same day turnaround when required. Using our own press and other specialist equipment, we manufacture rigging assemblies to order.



control equipment

Unusual offers a variety of control equipment, including our own distro system and a range of chain hoist motor controllers from Out Board and Kinesys.

Unusual's own distro system has been developed and refined over many years of use and personal experience. When you buy a system from us, you are buying years of accumulated knowledge built into a robust, modular system that can be built to suit your own specific requirements. Full details can be seen on the Unusual website www.unusual.co.uk

Drawing on the extensive experience of event rigging professionals, Out Board has developed a comprehensive range of compact but rugged chain-hoist motor controllers and accessories built to survive the rigours of touring life:

- The LV-Series can operate all Liftket and other Low-Voltage control hoists; 6, 8, and 12-channel.
- The DV-Series can operate all Liftket and other Direct Control hoists; 4 and 8 channels.

The Elevation1+ from Kinesys removes the need for large quantities of cabling and permits a number of motors and controllers to be supplied by single power and data cables.

UNUSUAL



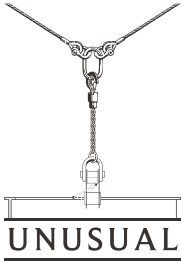

Unusual Rigging Ltd
The Wharf
Bugbrooke
Northamptonshire
NN7 3QB
UK

Tel: +44 1604 830083
info@unusual.co.uk
unusual.co.uk



Unusual Rigging & Engineering LLC
P.O. Box 283586
Dubai
UAE

Tel: +971 (0) 4 885 9009
Fax: +971 (0) 4 813 5145
dubai@unusualrigging.com
unusualrigging.com



Corporate
Supporter
2014

